

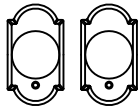

PASSAGE/PRIVACY INSTALLATION INSTRUCTIONS



350N



250N

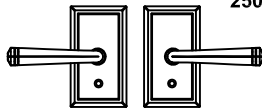

460

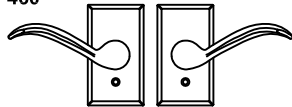

760N

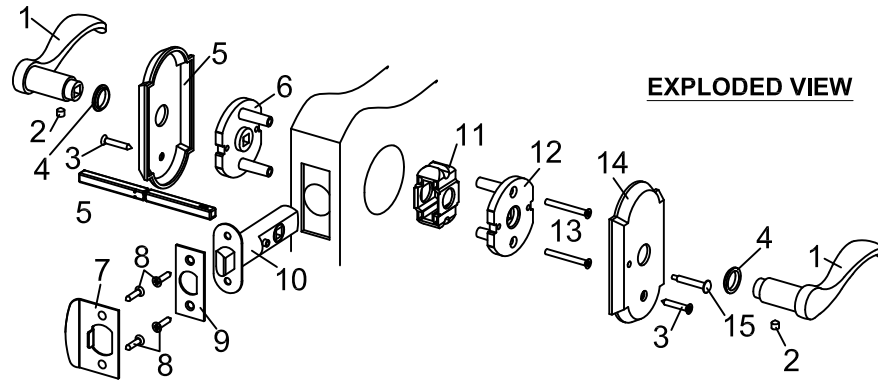

EXPLODED VIEW

- | | | |
|------------------------|----------------------------|--------------------------------|
| 1. KNOB OR LEVER | 6. EXTERNAL MOUNTING PLATE | 11. LATCH SUPPORT |
| 2. SET SCREW | 7. LATCH STRIKE | 12. INTERNAL MOUNTING PLATE |
| 3. WOOD SCREW | 8. COMBO SCREW | 13. MOUNTING SCREW |
| 4. NYLON WASHER | 9. LATCH FACE PLATE | 14. INTERNAL TRIM PLATE |
| 5. EXTERNAL TRIM PLATE | 10. LATCH | 15. PRIVACY PIN (PRIVACY ONLY) |

INSTALLATION FASTENERS



(4) WOOD SCREW
#8 x 1"



(4) COMBO SCREW
#10 x 1"

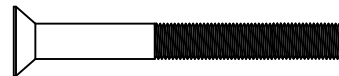

(2) MOUNTING SCREW
#10-24 x 1-1/2"

BEFORE YOU BEGIN

Check door thickness as handle will work with a 1-3/8" to 1-3/4" thick door only.

Remove and discard all packaging materials and verify you have all the parts in the exploded view section of instructions

Follow step by step installation instructions to ensure proper operation of handle set.

Always wear protective eyewear.

REQUIRED TOOLS

- | | |
|--------------------------|------------------|
| -1/8" Drill Bit | -1/2" Chisel |
| -1" Hole Saw | -2-3/8" Hole Saw |
| -#2 Phillips Screwdriver | -Drill |
| -Measuring Tape | -Pencil |
| -Protective Eyewear | -Utility Knife |

1. Fold the template along the dotted line and position on the door at the desired height (typically 40" from the bottom of the door). If door is beveled, place folded edge on low side of bevel as shown in illustration.

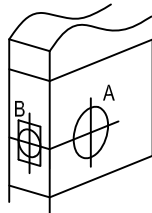
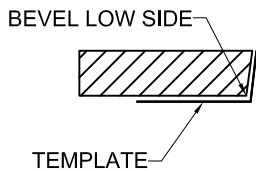

2. Determine the backset and mark the backset center points (A, B) on the template. The most common backset is 2-3/8".

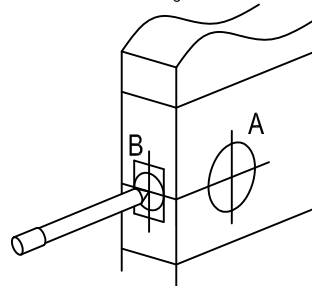

3. Carefully using a 2-1/8" diameter hole saw drill through hole A. Drill a 1" diameter hole through B. IMPORTANT: DRILL PERPENDICULAR (90°) TO DOOR.

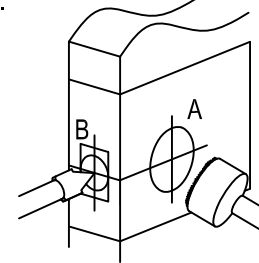

4. Insert the latch with the latch face plate into the hole and with a utility knife outline the latch face plate ensuring the outline is parallel to the door.

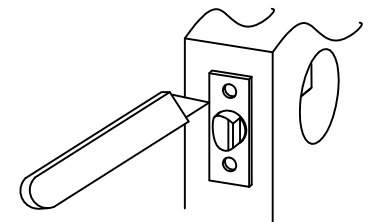

5. Chisel face plate marking to a depth of 1/8" or until the latch face plate is flush with door edge.

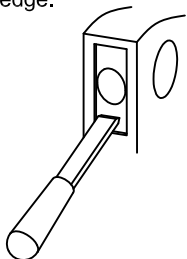

6. Using the strike template mark, the mounting screw hole and center markings of the latch strike plate.

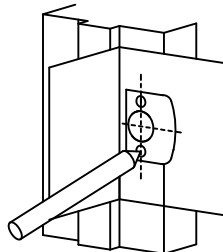

7. Align the latch strike plate using the screw hole locations and trace the outline of the latch strike plate.

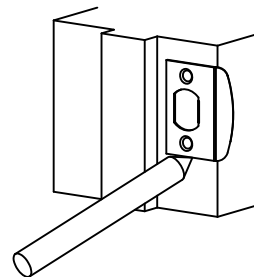

8. Bore a 1" dia. holes at the center marking of the dead bolt strike plate 1" deep. With a utility knife score and chisel edge markings into the door frame until strike plate is flush with the door frame (approximately 1/16").

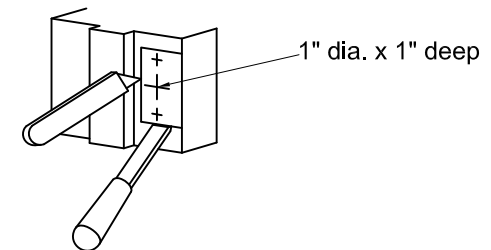

9. Using the latch strike plate as template mark and drill (2) 1/8" pilot holes.

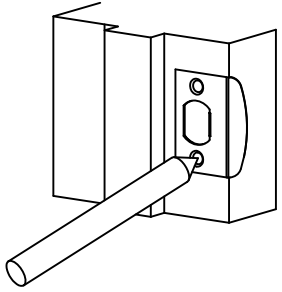

10. Secure the latch strike in place using (2) combo screws.

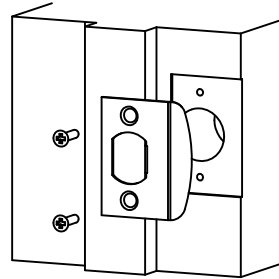

11. Place the latch support into the face bore and insert the latch into the door panel and latch support. For a privacy set, ensure the threaded stud is facing the internal side of the door.

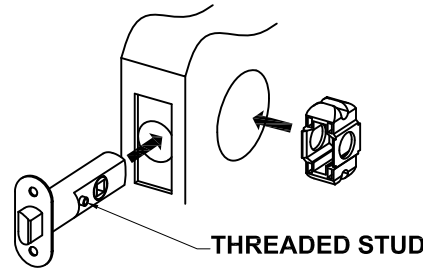

12. The curved side of the latch bolt must face the door jamb. Orient the latch bolt by rotating the latch bolt half a turn.

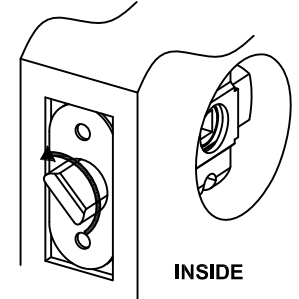

13. Place the latch face plate over the latch bolt and secure in place using 2 combo screws.

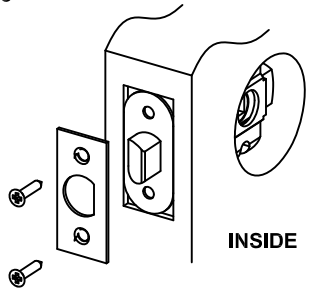

14. From the outside of the door insert the spindle with the groove side down and the stamped arrow towards the square hole of the latch. Slide the spindle through the latch until the split line of the spindle is in the center of the latch.

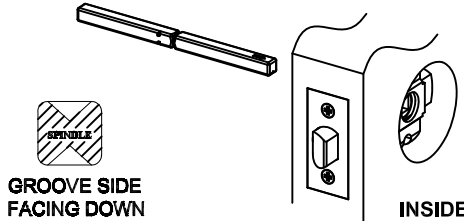

15. From the outside of the door install the outside mounting plate and from the inside of the door install the inside mounting plate. Secure the mounting plates in place using 2 mounting screws.

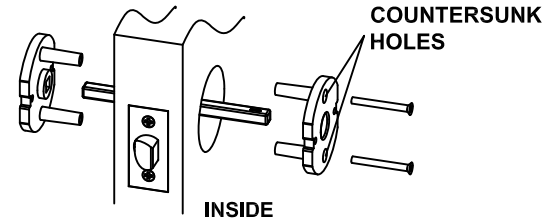

16. Place the plastic washer on the shank of the knob or lever.

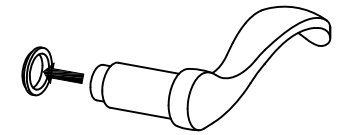

17. From the inside of the door position the internal trim plate onto the mounting plate and slide the lever onto the spindle. Push the spindle from the outside of the door and press the lever firmly against the trim plate. Secure the lever in place with the set screw. For a privacy set, the internal trim plate has the larger hole for the privacy pin.

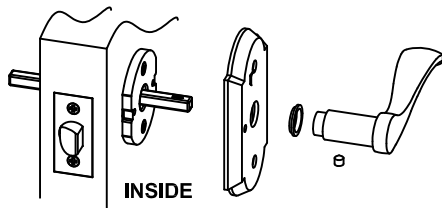

18. Align the internal trim with the edge of the door and mark the position of the top and bottom screw hole locations. Drill a 1/8" pilot hole and secure the Rosette plate in place with the wood screw. For a PRIVACY SET, screw in the privacy pin into the latch.

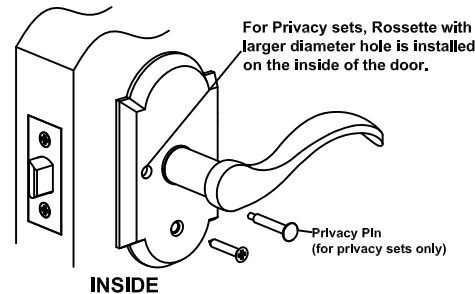

19. From the outside of the door position the external trim onto the mounting plate and slide the lever onto the spindle. Press the lever firmly against the trim plate and secure the lever in place with the set screw.

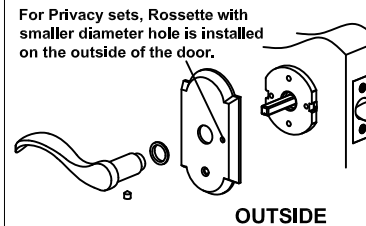

20. Align the external trim with the edge of the door and mark the position of the top and bottom screw hole locations. Drill a 1/8" pilot hole and secure the external plate in place with wood screw.

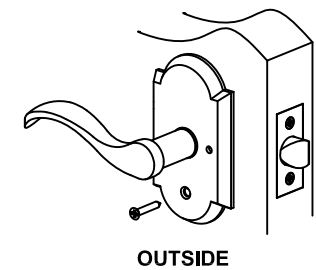

TROUBLE SHOOTING GUIDE

PROBLEM

After depressing the knob or lever does not return to horizontal position

SOLUTION

Handle set is not properly aligned. Remove the knob or lever, trim plates, and loosen the mounting screws. Align the mounting mounting plates and re-installed the trim plates and knob or lever.

Knob or lever is easily pulled off

The spindle is not oriented properly. Remove the knobs or levers, trim plates, and mounting plates. Remove the spindle and reinsert the spindle into the latch ensuring the "V" groove is facing down. Re-install the mounting plates, trim plates, and knobs or levers.

Privacy pin is located on the wrong side

Remove the knobs or levers, trim plates, mounting plates, and latch. Rotate the latch 180° and re-install mounting plates, trim plates, and knobs or levers.